

Revision Notes			
R1 -	Drawn:-	Checked:-	Approved:-
AP: -			Date -

ITEM	PART NO.	QTY	MODEL/DESCRIPTION
①	(#3481B)	1	BE-800C(40)-C CAMERA ONLY
②	(#3244)	1	BE-89XC/BE-X0XC-BKT CAMERA BRACKET
③	(#3245)	1	BE-89XC/BE-X0XC-SS CAMERA SUNSHIELD
④	(#3246)	1	BE-2XXC/8XXC-FIX CAMERA FIXING PACK
⑤	(#3247A)	1	BE-89XC/BE-X0XC-IG INSTALLATION GUIDE (NOT SHOWN)

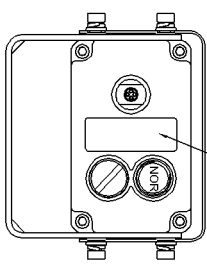

VIEW A

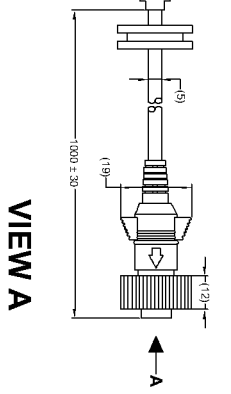
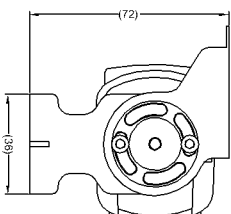
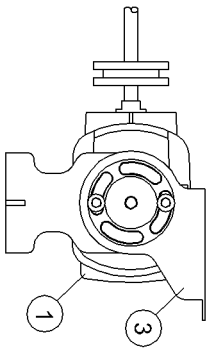
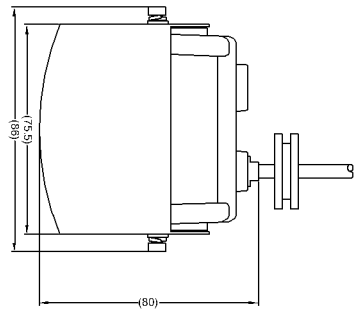
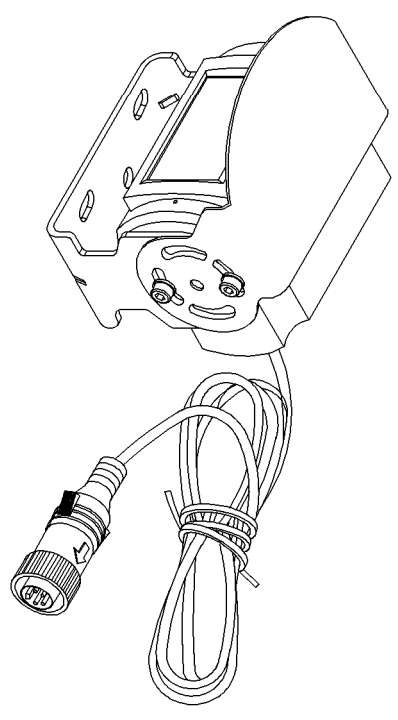
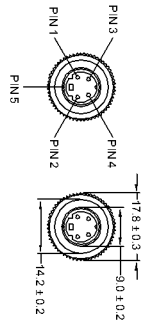

4 PIN MINI DIN MALE MATING FACE

PIN #	WIRE COLOUR	DESCRIPTION
1	YELLOW	VIDEO
2	RED	+12V
3	BLUE	N/C
4	WHITE	AUDIO
5	BLACK/SHIELD	GND

NOTES:

- REFER TO "PRODUCT SPECIFICATION" FOR MORE DETAILS.
- REFER TO COMPONENT DRAWINGS FOR COMPONENT DETAILS.
- ENSURE SELF-AMALGAMATING TAPE IS USED DURING INSTALLATION.
- ANY CUSTOMER MODIFICATION OF THIS PRODUCT CAUSING SUBSEQUENT FAILURE IS NOT A LIABILITY OF BRIGADE ELECTRONICS PLC.
- FOR FITBOX LABEL REFER TO LATEST REVISION OF DRAWING BE-002901-XX-14.
- FOR SERIAL NUMBER LABEL REFER TO LATEST REVISION OF DRAWING BE-001655-XX-11.
- PURCHASE ORDER TO DEFINE PACKAGING VARIANT.
- REFER TO LATEST REVISION OF DRAWING BE-002926-XX-14 FOR PACKAGING DETAILS.

PROPRIETARY NOTICE

THIS DESIGN AND TECHNICAL INFORMATION APPEARING ON THIS DRAWING IS THE PROPERTY OF BRIGADE ELECTRONICS, AND IS DISCLOSED IN CONFIDENCE. IT IS NOT TO BE COPIED, REPRODUCED, REVEALED TO OR EXPLOITED BY OTHERS, EITHER IN WHOLE OR IN PART WITHOUT THE EXPRESS WRITTEN CONSENT OF BRIGADE ELECTRONICS.

BRIGADE®
www.brigade-electronics.com

<p>Angle of Projection Third Angle</p>	Assembly PI Approval T.CHOI		Approved by B.JOHN	Checked by R.BATES	Drawn by A.FEDERIGHI
	Units mm	Scale N/A	Released 27/06/14	Assembly Ref ECC-72H	
Status RELEASED	BE-800C(40)				
Part No #1559C	BE-002934-00-14				